















Collezione "AMBRA" marrone (Listino terza fascia)
Brown "AMBRA" Collection (Price list 3rd type)

	Umidiera bombata c/c Stew dish billied with lid cod. 081 + 091 cm. 23x12,5		Pentola 2 manici c/c Billied pot with two handles and lid cod. 084 + 091 cm. 21x18		Insalatiera Gaia Salad bowl Gaia cod. 430 cm. Ø 24
	Casseruola bombata 2 manici c/c Series billied casserole with two handles and lid cod. 073 + 090 cm. 20x8 cod. 074 + 091 cm. 23x9		Boccale bombato "S"- Jug billied "S" Cod. 733 lt.1 Cod. 732 lt. 0,5 Cod. 731 lt. 0,250		Piatto frutta "GAIA" Fruit plate "GAIA" cod. 810 cm. Ø 19
	Casseruola bombata 2 manici Billied casserole with 2 handles cod. 070 cm. 12x4,7 cod. 071 cm. 14x5 cod. 072 cm. 17x7		Bicchere bombato con manico Beakers billied with handle Cod. 700		Fondo "Gaia" Soup plate "Gaia" cod. 811 cm. Ø 21
	Casseruola 1 manico rotondo c/c Casserole with one round handle with lid cod. 016 cm. 22x9		Ovale liscio Smooth oval cod. 503 cm. 35x25x7		Piano / Plate cod. 812 cm. Ø 23



DE SILVA CERAMICHE SRL

Sede legale: Via Gramsci, 19 - Passignano sul Trasimeno - Perugia
 Stabilimento: Zona Industriale Nord - 06023 Gualdo Tadino (PG)

Tel. 0759141431 - Fax 0759141431

E-mail: desilva@desilvaceramiche.it - Http://www.desilvaceramiche.it/



Collezione "ASSISI" (Listino terza fascia)
"ASSISI Collection (Price list 3° type)

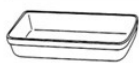

Pirola rettangolare liscia
Pyrex smooth rectangle
 cod. 551 cm. 32 x 27 x 6
 cod. 550 cm. 36 x 30 x 5



Pirola ovale
Series oval pyrex
 cod. 506 cm. 41 x 26 x 6
 cod. 505 cm. 25,5 x 14,5 x 4
 cod. 504 cm. 20,5 x 12,5 x 3



Umidiera
Stew dish
 cod. 030 cm. 15 x 9,5
 cod. 031 cm. 18 x 11,5
 cod. 032 cm. 21 x 13
 cod. 033 cm. 24 x 15



Pentola alta
Deep pot
 cod. 025 cm. 15 x 13
 cod. 026 cm. 18 x 16
 cod. 027 cm. 21 x 18



Zuppino 2 manici
Soup bowl with two handles
 cod. 290 cm. 13 x 6,5



Lattiera cilindrica grande
Big cylindrical milk - jug
 cod. 761



Lattiera bassa
Low milk - jug
 cod. 755



Bicchiere bombato
Series billied beaker
 cod. 700



Balena
Series balena
 cod. 729 lt. 0,5
 cod. 730 lt. 1



Burriera piccola
Small butter holder
 cod. 352



Copriformaggio con piatto
Cheese plate with lid
 cod. 350 piccolo / small
 cod. 351 grande / big



Biscottiera c/c
Biscuit vase with lid
 cod. 950 cm. 16 x 14
 cod. 905 cm. 12 x 13



Colazione per 2 / vassoio ovale
Breakfast for 2 with oval tray
 cod. OCO



Botte c/c
Cask with lid
 cod. 915 cm. 9 x 13
 cod. 916 cm. 11 x 15
 cod. 917 cm. 16 x 19



Vaso cucina c/c
Kitchen vase with lid
 cod. 900 cm. 9 x 11
 cod. 901 cm. 12 x 13
 cod. 902 cm. 13 x 15
 cod. 903 cm. 15 x 18



Pentolino bombato c/c s/m
Series billied small pot with lid
 cod. SMP cm. 8 x 5,5
 cod. SMT cm. 10 x 9,5



Casseruola 1 manico
Casserole with one handle
 cod. 008 cm. 12 x 5
 cod. 009 cm. 15 x 6
 cod. 010 cm. 18 x 7
 cod. 011 cm. 21 x 8
 cod. 012 cm. 24 x 8,5
 cod. 013 cm. 27 x 10



Casseruola 2 manici
Casserole with two handles
 cod. 001 cm. 12x5
 cod. 002 cm. 15x6
 cod. 003 cm. 18x7
 cod. 004 cm. 21x8
 cod. 005 cm. 24x8,5
 cod. 006 cm. 27x10
 cod. 007 cm. 30x11



Catino
Basin
 cod. 328 cm. 10 x 4,5
 cod. 330 cm. 25 x 14



Insalatiera "A"
Salad bowl "A"
 cod. 835 cm. 24 x 10



Piatto frutta ciotola
Fruit bowl
 cod. 800 cm. Ø 19



Pianno / Plate
 cod. 813 cm. Ø 27



Piatto fondo ciotola
Soup plate
 cod. 801 cm. Ø 18

Piatto piano ciotola
Plate bowl
 cod. 802 cm. Ø 23



Ciotolone 2 manici
Big bowl / two handles
 cod. 203 cm. Ø 10
 cod. 200 cm. Ø 16
 cod. 202 cm. Ø 25
 cod. 201 cm. Ø 30



Vassoio ovale
Series oval tray
 cod. 649 cm. 20 x 3,5
 cod. 650 cm. 27,5 x 17
 cod. 651 cm. 33 x 19
 cod. 652 cm. 37 x 23



Teglia 1 manico
Baking pans with one handle
 cod. 256 cm. 15 x 4,5
 cod. 257 cm. 18 x 5



DE SILVA CERAMICHE SRL

Sede legale: Via Gramsci, 19 - Passignano sul Trasimeno - Perugia
 Stabilimento: Zona Industriale Nord - 06023 Gualdo Tadino (PG)
 Tel. 0759141431 - Fax 0759141431

E-mail: desilva@desilvaceramiche.it - [Http://www.desilvaceramiche.it/](http://www.desilvaceramiche.it/)



Collezione "AUTUNNO" (Listino terza fascia)
"AUTUNNO" Collection (Price list 3° type)



Rostiera c.c.
Roast dish with lid
 cod. 575 cm. 42,5 x 27 x 8
 cod. 576 cm. 32,5 x 21 x 6,5



Insalatiera
Salad bowl
 cod. 855 cm. 16 x 7
 cod. 856 cm. 25 x 9,5
 cod. 857 cm. 28 x 11



Budino
Pudding
 cod. 620 cm. 25 x 10,5



Poubelle de table c.c.
Poubelle de table with lid
 cod. 945 piccola / small
 cod. 947 grande / big



Boccale svasato
Jugs series flared
 cod. 740 cm. h. 17



Tino
Tin
 cod. 940 piccolo / small
 cod. 941 grande / big



Zuppiera c.c.
Soup-tureen with lid
 cod. ZUP



Tazzina "L"
"L" cup cod. 871 cm. 6 x 6,5
Piattino caffè
Coffee dish cod. 875 cm. Ø 13



Boccale bombato "S"
Billed jugs "S"
 cod. 734 lt. 1,5 cod. 731 lt. 0,250
 cod. 733 lt. 1 cod. 730 lt. 0,200
 cod. 732 lt. 0,5



Porta aglio bombato
Series billed garlic rack
 cod. 905 cm. 12 x 13



Colazione per 2 / vassoio ovale
Breakfast for 2 with oval tray
 cod. OCJ



Bombato con manico
Series billed with handle cod. 700



Servito thé per 2
Thé for 2 with oval tray
 cod. OTM



Tazza brodo
Broth cup
 cod. 628 cm. 14 x 8



Vassoio rettangolare liscio
Smooth rectangle tray
 cod. 533 cm. 33 x 28 x 2
 cod. 532 cm. 33 x 28 x 8



Crucipane
Bake - bread
 cod. 570 cm. 39 x 19 x 17
 cod. 571 cm. 42 x 24 x 20



Casseruola 2 manici
Casserole with two handles
 cod. 001 cm. 12x5
 cod. 002 cm. 15x6
 cod. 003 cm. 18x7
 cod. 004 cm. 21x8
 cod. 005 cm. 24x8,5
 cod. 006 cm. 27x10
 cod. 007 cm. 30x11



Vassoio ovale pesce
Oval fish tray
 cod. 649 cm. 20 x 35
 cod. 650 cm. 27,5 x 17
 cod. 651 cm. 33 x 19
 cod. 652 cm. 37 x 23



Pentolina bombata 2 manici c.c.
Series billed pot / two handles and lid
 cod. 120 cm. 8 x 7,5
 cod. 121 cm. 10 x 9
 cod. 122 cm. 11 x 11
 cod. 123 cm. 11 x 14



Stampo limone
Print lemon
 cod. 360



Ciotolone 2 manici
Big bowl / two handles
 cod. 203 cm. Ø 10
 cod. 200 cm. Ø 16
 cod. 202 cm. Ø 25
 cod. 201 cm. Ø 30













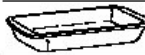

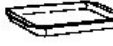

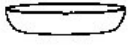





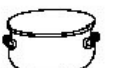

Porta mestolo
Ladle holder
 cod. 355



DE SILVA CERAMICHE SRL
 Sede legale: Via Gramsci, 19 - Passignano sul Trasimeno - Perugia
 Stabilimento: Zona Industriale Nord - 06023 Gualdo Tadino (PG)
 Tel. 0759141431 - Fax 0759141431
 E-mail: desilva@desilvaceramiche.it - <http://www.desilvaceramiche.it/>



Collezione "BOTANICA" (Listino terza fascia)
 "BOTANICA" Collection (Price list 3° type)

	Rettagolo - Rectangle cod. 536 cm. 30x20x6 cod. 537 cm. 38x24x6,5		Boccale bombato "S" - Jug billed "S" cod. 734 lt. 1,15 cod. 733 lt. 1 cod. 732 lt. 0,5 cod. 731 lt. 0,250 cod. 730 lt. 0,200
	Rettagolo - Rectangle cod. 540 cm. 40x28x7 cod. 541 cm. 23,5x13x4,5		Bicchieri bombato senza manico Beakers billed without handle cod. 701
	Ovale PB. liscio Smooth series oval cod. 500 cm. 20x3,5x4,5 cod. 501 cm. 25x17x5,5 cod. 502 cm. 35x25x7 cod. 503 cm. 32x22x5,5 cod. 499 cm. 40x27x8,5		Bottiglie - Bottles cod. BMP small with handle cod. BGM big with handle
	Casseruola bombata 2 manici Billed casserole with 2 handles cod. 070 cm. 12x4,7 cod. 071 cm. 14x5 cod. 072 cm. 17x7 cod. 073 cm. 22x8 cod. 074 cm. 23x9 cod. 075 cm. 26x9,5		Insalatiera - Salad bowl cod. 835 cm. 24x10
	Casseruola bombata 1 manico Billed casserole with 1 handle cod. 060 cm. 12x4,7 cod. 061 cm. 14x5 cod. 062 cm. 17x7 cod. 063 cm. 20x8 cod. 064 cm. 23x9 cod. 065 cm. 26x9,5		Pinzonio senza manico Crudité dipper without handle cod. 302 8x5
	Umidiere bombata Billed stew dish cod. 080 cm. 20x10,5 cod. 081 cm. 24x12,5		Fondo ciotola - Soup plate cod. 801 cm. Ø 18
	Coperchio bombato Series billed lid cod. 080 cm. 17 cod. 090 cm. 20 cod. 091 cm. 24		Piatto piano - Plate cod. 802 cm. Ø 23
	Orcio - Jar cod. 930 cm. 10x15 small cod. 931 cm. 17x19 big		Frutta ciotola - Fruit bowl cod. 800 cm. Ø 19
	Cuoci legumi - Boll legume cod. ATO		Piatto pizza - Plate pizza cod. 806 cm. Ø 32
	Portamestolo - Ladle holder cod. 355 cm. 28x21x13,6		Teiera - Teapot cod. 999
			Tazza colazione con piatto Breakfast cup with dish cod. FTP cm. 11x2
			Tazza caffè con piatto Coffee cup with dish cod. NTC
			Zuccheriera bombata Sugar basin billed cod. 965



DE SILVA CERAMICHE SRL









Sede legale: Via Gramsci, 19 - Passignano sul Trasimeno - Perugia

Stabilimento: Zona Industriale Nord - 06023 Guadalupe (PG)

Tel. 0759141431 - Fax 0759141431

E-mail: desilva@desilvaceramiche.it - Http://www.desilvaceramiche.it/

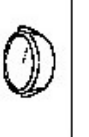
Collezione "ILARIA" Colore Cuoio (Listino prima fascia)
"ILARIA" Collection Leather Colour (Price list 1° type)

	Dim.	Cod. nuovo New code	Pz.	Lit.
 Casseruola 2 manici Casseroles with two handles	12	001	12	0,300
	15	002	12	0,500
	18	003	6	1
	21	004	6	1,7
	24	005	6	2,5
	27	006	4	3,5
30	007	4	5,5	
 Casseruola 1 manico Casseroles with one handle	12	008	12	0,300
	15	009	12	0,500
	18	010	6	1
	21	011	6	1,7
24	012	6	3,5	
 Pentola alta Deep pot	15	025	6	1,7
	18	026	6	2,9
	21	027	4	4,6
 Umidiere Stew dish	15	030	6	1
	18	031	6	2
	21	032	6	3
	24	033	4	5
 Teglia Baking-pan	15	250	6	0,700
	18	251	4	3,4
	30	255	12	0,400
 Coperchio Lid	15	040	12	
	18	041	6	
	21	042	6	
	24	043	6	
 Zuppino Soup bowl	13	280	12	0,500
 Lattiera alta Deep milk jug	9	756	6	0,520
 Lattiera bassa Shallow milk jug	12	755	6	0,420

















DE SILVA CERAMICHE SRL

Sede legale: Via Gramsci, 19 - Passignano sul Tirasimeno - Perugia
 Stabilimento: Zona Industriale Nord - 06023 Guardo Tadino (PG)
 Tel. 0759141431 - Fax 0759141431
 E-mail: desilva@desilvaceramiche.it - Http://www.desilvaceramiche.it/



Colore Cuoio (Listino prima fascia)
Leather Colour (Price list 1° type)

	Cm.	Cod.	Pz.	Cl.
	19	800	12	
Piatto frutta Fruit dish Assiette a dessert Obstteller Plato fruta				
	18	801	12	100
Piatto fondo Soup plate Assiette creuse Tiefler Teller Plato hondo				
	23	802	12	
	26	803	12	
	29	805	12	
	32	806	6	
Piatto piano Plate Assiette plate Flacher teller Plato llano				
	19	810	12	
Piatto frutta Gaia Fruit dish Gaia Assiette a dessert Gaia Obstteller Gaia Plato fruta Gaia				
	21	811	12	
Piatto fondo Gaia Soup plate Gaia Assiette creuse Gaia Tiefler Teller Gaia Plato hondo Gaia				
	23	812	12	
	30	815	6	
	26	814	12	
	27	813	6	
	31	820	4	
	32	821	4	
Piatto piano Gaia Plate Gaia Assiette plate Gaia Flacher teller Gaia Plato llano Gaia				



DE SILVA CERAMICHE SRL

Sede legale: Via Gramsci, 19 - Passignano sul Trasimeno - Perugia

Stabilimento: Zona Industriale Nord - 06023 Gualdo Tadino (PG)

Tel. 0759141431 - Fax 0759141431

E-mail: desilva@desilvaceramiche.it - [Http://www.desilvaceramiche.it/](http://www.desilvaceramiche.it/)

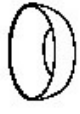
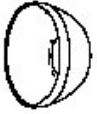

Colore Cuoio (Listino prima fascia)
Leather Colour (Price list 1° type)

	Cm.	Cod. nuovo New code	Pz.
 Insalatiera Gaia <i>Salad bowl/ Gaia</i>	24	830	4
	 Ciotola "A" <i>Bowl "A"</i>		
 Ciotola "B" <i>Bowl "B"</i>	10	845	12
	13	840	6
	18	841	4
	23	842	4
	28	843	1
	32	844	1



DE SILVA CERAMICHE SRL

Sede legale: Via Gramsci, 19 - Passignano sul Trasimeno - Perugia







Stabilimento: Zona Industriale Nord - 06023 Guardo Tadino (PG)

Tel. 0759141431 - Fax 0759141431

E-mail: desilva@desilvaceramiche.it - [Http://www.desilvaceramiche.it/](http://www.desilvaceramiche.it/)



Cm. Cod Pz.

 <p>SERVIZIO PINZIMONIO 7 PZ. 1 piatto Ø cm. 26 - 6 ramequin piccolo cm. 8 1 dish Ø cm. 26 - 6 small ramekins 1 Plat de 26 cm. Ø - 6 petits ramequins 1 Teller Ø cm. 26 - 6 Ramequin klein 1 plato Ø cm. 26 - 6 Ramequin pequeño</p>	517
 <p>SERVIZIO PINZIMONIO 7 PZ. 1 piatto Ø cm. 26 - 6 ciocoline Ø cm. 8 - 1 manico 1 dish Ø cm. 26 - 6 petites ecuelles de 18 cm. Ø 8 1 manche 1 Teller Ø cm. 26 - 6 Schlüsselchen m. Griff, Ø cm. 19 1 Plato Ø cm. 26 - 6 escudillas Ø cm. 18 1 asa</p>	518
 <p>SERVIZIO PINZIMONIO 7 PZ. 1 pentola Ø cm. 16 - 6 pentolini Ø cm. 8 Mimi 1 pot Ø 16 cm. - 6 individual small pots Ø 8 cm. 1 Tirolo de 16 cm. Ø - 6 petits casseroles de 8 cm. Ø Mimi 1 Topf Ø 16 cm. - 6 Töpfchen Ø cm. 8. Mimi 1 olla Ø cm. 16 - 6 ollitas Ø cm. 8 Mimi</p>	519
 <p>Pinzimonio pressa cm. 8 1 crudite dipper series pressa with two handles 1 casserole pour potirades pressa avec manche 1 Dipper serie in wood pressa 1 salsera para pebrada pressa con asa</p>	8 065 24
 <p>Ramequin piccolo cm. 8 1 small ramekin 1 petit ramequin 1 Ramequin klein 1 Ramequin pequeño</p>	066 24
 <p>Pinzimonio 2 manici pentolino cm. 8 Mimi 1 crudite dipper bowl with two handles 1 casserole pour potirades avec 2 poignées 1 Dipper-Service m. 2 Griffen, Töpfchen 1 Salsera para pebrada 2 asas ollita</p>	8 067 24
 <p>Pentola bombata 2 manici 1 Filled pot with two handles 1 Pot rempli de soupe avec poignées 1 Topf m. 2 Griffen, bauchig 1 Olla convexa 2 asas</p>	16 032



DE SILVA CERAMICHE ARTISTICHE SRL
 SEDE LEGALE: VIA GRAMSCI, 19 - FASSIGNANO SUL TRASIMENO - PERUGIA
 STABILIMENTO: ZONA INDUSTRIALE NORD - 06023 GUALDO TADINO (PG)
 TEL. (075) 9141431 - FAX 9141431



Collezione "ELIOS" "Elios" Collection



Umidiera
Stew dish
cod. 030+040 cm. 15x9,5
cod. 031+041 cm. 18x11,5
cod. 032+042 cm. 21x13
cod. 033+043 cm. 24x15



Insalatiera
Salad bowl
cod. 836 cm. 29x11



**Umidiera bombata 1 manici con
coperchio Etrusca**
*Billied stew dish with 1 handles lid
Etrusca*
cod. 238+241 cm. 21x12,5



Tazza thè bombata con piatto thè
Billied tea cup with tea dish
cod. 867+876 cm. 8x8,5



Casseruola 1 manico tondo
Casserole with 1 round handle
cod. 049 cm. 12
cod. 050 cm. 15
cod. 051 cm. 18
cod. 052 cm. 21
cod. 053 cm. 24
cod. 056 cm. 27
cod. 057 cm. 30
cod. 058 cm. 33



Tazza bombata 02 + piatto colazione
Billied cup 02 + breakfast dish
cod. 866+865 cm. 10x9,5



Boccale bombato
Billied jug
cod. 734 Lt. 1,5
cod. 733 Lt. 1
cod. 732 Lt. 0,50
cod. 731 Lt. 0,25
cod. 730 Lt. 0,20



Casseruola 2 manici
Casserole with 2 handles
cod. 001 cm. 12x5
cod. 002 cm. 15x6
cod. 003 cm. 18x7
cod. 004 cm. 21x8
cod. 005 cm. 24x8,5
cod. 006 cm. 27x10
cod. 007 cm. 30x11
cod. 022 cm. 33x11



Piatto frutta
Fruit plate
cod. 800 cm. 20x2,5



Piatto fondo
Soup plate
cod. 801 cm. 19x6
cod. 802 cm. 23



Rettangolo
Rectangle
cod. 536 cm. 30x20x6
cod. 537 cm. 38x24x6,5
cod. 538 cm. 34,5x23,5x6



Piatto piano
Plate
cod. 803 cm. 26



Cuocipane
Bake bread
cod. 570 cm. 39x19x17
cod. 571 cm. 42x24x20



Piatto piano
Plate
cod. 805 cm. 25



Zuppino 2 manici fascia
Soup bowl
cod. 099 cm. 13





















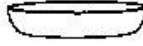

DE SILVA CERAMICHE SRL

Sede legale: Via Gramsci, 19 - Passignano sul Trasimeno - Perugia
Stabilimento: Zona Industriale Nord - 06023 Gualdo Tadino (PG)
Tel. 0759141431 - Fax 0759141431
E-mail: desilva@desilvaceramiche.it - Http://www.desilvaceramiche.it





Collezione "GUBBIO"
"GUBBIO" Collection

 <p>Umidiera <i>Stew dish</i> cod. 030 cm. 15x9,5 cod. 031 cm. 16x11,5 cod. 032 cm. 21x13 cod. 033 cm. 24x15</p>	 <p>Ciotolone 2 manici <i>Big bowl / two handles</i> cod. 203 cm. Ø 10x5 cod. 204 cm. Ø 16x7 cod. 202 cm. Ø 25x9,5 cod. 201 cm. Ø 30x11</p>	 <p>Frutta ciotola - Fruitbowl cod. 600 cm. Ø 19</p>
 <p>Coperchio <i>Lid</i> cod. 040 cm. Ø 15 cod. 041 cm. Ø 18 cod. 042 cm. Ø 21 cod. 043 cm. Ø 24</p>	 <p>Vassoio ovale <i>Series oval tray</i> cod. 649 cm. 20 x 3,5 cod. 650 cm. 27,5 x 17 cod. 651 cm. 33 x 19 cod. 652 cm. 37 x 23</p>	 <p>Piatto piano - Plate cod. 602 cm. Ø 23 cod. 603 cm. Ø 26</p>
 <p>Casseruola 2 manici a fascia <i>Casserole with two handles</i> cod. 100 cm. 12x5 cod. 101 cm. 15x5 cod. 102 cm. 16x7 cod. 103 cm. 21x5 cod. 104 cm. 24x5,5 cod. 105 cm. 27x10 cod. 106 cm. 30x11</p>	 <p>Vassoio ovale pesce <i>Oval fish tray</i> cod. 657 cm. 26 x 13x4,5 cod. 656 cm. 33x16,5x5,5 cod. 655 cm. 42x21x5</p>	 <p>Fondo ciotola - Soup plate cod. 601 cm. Ø 18</p>
 <p>Casseruola 1 manico <i>Casserole with one handle</i> cod. 006 cm. 12x5 cod. 009 cm. 15x5 cod. 010 cm. 16x7 cod. 011 cm. 21x5 cod. 012 cm. 24x5,5 cod. 013 cm. 27x9</p>	 <p>Ovale P.B. liscio <i>Smooth series oval</i> cod. 500 cm. 20x13,5x4,5 cod. 501 cm. 25x17x5,5 cod. 502 cm. 32x22x5,5 cod. 503 cm. 35x25x7 cod. 499 cm. 40x27x5,5</p>	 <p>Bicchiere senza manici <i>Beaker without handles</i> cod. 714 cm. h.10 cod. 716 cm. h.13,5</p>
 <p>Casseruola cilindrica 2 manici con c.t. <i>Cylindrical casserole with two handles and lid</i> cod. 240 cm. 6 x 5 cod. 241 cm. 10 x 5,5</p>	 <p>Biscottiera c.t. <i>Biscuit vase with lid</i> cod. 990 cm. 16 x 14</p>	 <p>Bicchiere con manico <i>Beaker with handle</i> cod. 716 cm. h.10 cod. 717 cm. h.13,5</p>
 <p>Portanestolo - Ladle holder cod. 355 cm. 26x12</p>	 <p>Vaso cucina <i>Kitchen vase</i> cod. 905 cm. 12 x 13</p>	 <p>Tazza thé <i>Tea cup</i> cod. 664 cm. 10x9</p>
		 <p>Piatto thé <i>Tea cup</i> cod. 676 cm. Ø16</p>
		 <p>Porta bambon <i>Bambon holder</i> cod. 370</p>
		 <p>Catino <i>Basin</i> cod. 330 cm. 25 x 14 cod. 328 cm. 10 x 4,5</p>



DE SILVA CERAMICHE SRL

Sede legale: Via Gramsci, 19 - Passignano sul Trasimeno - Perugia
Stabilimento: Zona Industriale Nord - 06023 Gualdo Tadino (PG)
Tel. 0759141431 - Fax 0759141431
E-mail: desilva@desilvaceramiche.it - [Http://www.desilvaceramiche.it/](http://www.desilvaceramiche.it/)



Collezione "LUNA"
"LUNA" Collection



Ovale / Oval
cod. 504 cm. 20x12,5x3
cod. 505 cm. 25x14,5x4
cod. 506 cm. 41x26x6



Casseruola svasata 1 manico
Casserole with 1 handle
cod. 019 cm. 22x8,5



Pentola con coperchio
Pot with lid
cod. 025 + 040 cm. 15x13
cod. 026 + 041 cm. 18x16
cod. 027 + 042 cm. 21x18



Casseruola 2 manici
Casserole with 2 handles
cod. 001 cm. 12x5
cod. 002 cm. 15x6
cod. 003 cm. 18x7
cod. 004 cm. 21x8
cod. 005 cm. 24x8,5
cod. 006 cm. 27x10
cod. 007 cm. 30x11
cod. 022 cm. 33x13



Piatto frutta Gaia
Fruit plate
cod. 810 cm. 19



Piatto fondo Gaia
Soup plate
cod. 811 cm. 21



Piatto piano Gaia
Plate
cod. 812 cm. 23



Piatto piano Gaia
Plate
cod. 814 cm. 26



Piatto piano Gaia
Plate
cod. 813 cm. 27



Insalatiera Gaia
Salad bowl
cod. 830 cm. Ø 24



Zuppino
Soup bowl
cod. 290 cm. Ø 13x6,5



Boccale Balena
Jug billied
cod. 728 lt. 1
cod. 729 lt. 0,5



Bicchiere Balena con manico
Beaker with handle
cod. 680 lt. 0,25







DE SILVA CERAMICHE SRL

Sede legale: Via Gramsci, 19 - Passignano sul Trasimeno - Perugia
Stabilimento: Zona Industriale Nord - 06023 Gualdo Tadino (PG)
Tel. 0759141431 - Fax 0759141431
e-mail: desilva@desilvaceramiche.it - <http://www.desilvaceramiche.it/>



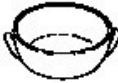

Colore Marrone (Listino prima fascia)
Brown Colour (Price list 1° type)

Collezione "ILARIA"
"ILARIA" Collection

	Cm.	Cod.nuova	Pz.	Lt.
	12 x 5	001	12	0,300
	15 x 6	002	12	0,500
	18 x 7	003	6	1
	21 x 8	004	6	1,7
	24 x 8,5	005	6	2,5
	27 x 10	006	4	3,5
	30 x 11	007	4	5,5
	12 x 5	008	12	0,300
	15 x 6	009	12	0,500
	18 x 7	010	6	1
	21 x 8	011	6	1,7
	24 x 8,5	012	6	3,5
	15 x 13	025	6	1,7
	18 x 16	026	6	2,9
	21 x 18	027	4	4,6
	15 x 9,5	030	6	1
	18 x 11,5	031	6	2
	21 x 13	032	6	3
	24 x 15	033	4	5
	15	040	12	
	18	041	6	
	21	042	6	
	24	043	6	

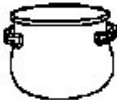
Collezione "MIMI"
"MIMI" Collection

	Cm.	Cod.nuova	Pz.	Lt.
	16 x 15,5	082	4	2,6
	18 x 16	083	4	3,5
	21 x 18	084	1	5
	17 x 18	135	1	
	22 x 19	136	1	

Ovali
Ovals

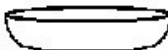



















	Cm.	Cod.nuova	Pz.
	20 x 13,5 x 4,5	500	6
	25 x 17 x 5,5	501	6
	32 x 22 x 5,5	502	4
	35 x 25 x 7	503	4
	40 x 27 x 8,5	499	1



DE SILVA CERAMICHE SRL
 Sede legale: Ma. Gramsci, 19 - Passignano sul Trasimeno - Perugia
 Stabilimento: Zona Industriale Nord - 06023 Gualdo Tadino (PG)
 Tel. 0759141431 - Fax 0759141431
 E-mail: desilva@desilvaceramiche.it - [Http://www.desilvaceramiche.it/](http://www.desilvaceramiche.it/)



Collezione "MEDITERRANEO"
 "MEDITERRANEO" Collection

	Casseruola 2 manici Casserole with two handles cod. 001 cm. 12x5 cod. 002 cm. 15x6 cod. 003 cm. 18x7 cod. 004 cm. 21x8 cod. 005 cm. 24x8,5		Vassoio ovale Series oval tray cod. 480 cm. 21,5x4 cod. 481 cm. 32,5x5 cod. 482 cm. 36x6		Casseruola bombata 2 manici Series billied casserole with two handles cod. FPB cm. 9x4
	Teglia 1 manico Baking pans with one handle cod. 258 cm. 30x8		Insalatiera "A" Salad bowl "A" cod. 835 cm. 24 x 10		Boccale svasato Jugs series flared cod. 740 cm. h. 17
	Padella alta 1 manico c/c Deep frying-pan with one handle and lid cod. 277 + 090 cm. 20x6,5 cod. 278 + 091 cm. 23x7 cod. 279 + 092 cm. 25,5x7		Stampo limone Print lemon cod. 360		Bicchiere senza manici Beaker without handles cod. 714 cm. h.10
	Teglia 2 manici Baking pans with two handles cod. 250 cm. 15x4,5 cod. 251 cm. 18x5		Portamestolo - Ladle holder cod. 355 cm. 28x12		Piatto frutta ciotola Fruit bowl cod. 800 cm. Ø 19
	Pentola alta c/c Deep pot with lid cod. 026 + 041 cm. 18 x 16		Biscottiera c/c Biscuit vase with lid cod. 950 cm. 16 x 14		Piatto piano ciotola Plate bowl cod. 802 cm. Ø 23
	Ovale liscio Smooth oval cod. 500 cm. 20x13,5x4,5 cod. 501 cm. 25x17x5,5 cod. 502 cm. 32x22x5,5 cod. 503 cm. 35x25x7		Vaso cucina Kitchen vase cod. 905 cm. 12 x 13		Piatto Plate cod. 813 cm. Ø 27
			Caffè per 2 / vassoio quadrato 2 cups of coffee with square tray cod. CAQ		Fondo ciotola Soup plate cod. 801 cm. Ø 18



DE SILVA CERAMICHE SRL

Sede legale: Via Gramsci, 19 - Passignano sul Trasimeno - Perugia
 Stabilimento: Zona Industriale Nord - 06023 Gualdo Tadino (PG)
 Tel. 0759141431 - Fax 0759141431
 E-mail: desilva@desilvaceramiche.it - [Http://www.desilvaceramiche.it/](http://www.desilvaceramiche.it/)



Collezione "METAL" (rosso) - "Metal" collection (red) (1° fascia + 15% - Price list 1° type + 15%)



Pentola bombata 2 manici con coperchio
Billed pot with lid two handles
 cod. 082 + 040 cm. 16 x 15,5
 cod. 083 + 041 cm. 20 x 16
 cod. 084 + 042 cm. 23 x 18



Rettangolo / Rectangle
 cod. 536 cm. 30 x 20 x 6
 cod. 537 cm. 38 x 24 x 6,5
 cod. 538 cm. 31,5 x 23,5 x 6



Umidiere bombata con coperchio
Billed stew dish with lid
 cod. 080 + 090 cm. 20 x 10,5
 cod. 081 + 091 cm. 23 x 12,5



Rettangolo / Rectangle
 cod. 532 cm. 38 x 20 x 6
 cod. 533 cm. 34 x 18 x 5,5
 cod. 536 cm. 30 x 16,5 x 4,5



Casseruola 2 manici
Casserole with 2 handles
 cod. 001 cm. 12 x 5
 cod. 002 cm. 15 x 6
 cod. 003 cm. 18 x 7
 cod. 004 cm. 21 x 8
 cod. 005 cm. 24 x 8,5
 cod. 006 cm. 27 x 10
 cod. 007 cm. 30 x 11
 cod. 022 cm. 33 x 11



DE SILVA CERAMICHE SRL

Sede legale: Via Gramsci, 19 - Passignano sul Trasimeno - Perugia
 Stabilimento: Zona Industriale Nord - 06023 Gualdo Tadino (PG)
 Tel. 0759141431 - Fax 0759141431
 e-mail: desilva@desilvaceramiche.it - <http://www.desilvaceramiche.it/>

Collezione "SAFARI ROSSO" "Red Safari" Collection



Tagina grande
Large tagine
cod. 353 cm. 25x26
cod. 341 cm. 20x13



Pentola bombata Etrusca
Billied pot Etrusca
cod. 219+240 cm. 11,5x15
cod. 220+241 cm. 18x22



Casseruola bombata 2 manici Etrusca
Billied casserole with 2 handles Etrusca
cod. 225 cm. 15x7
cod. 226 cm. 22x9
cod. 227 cm. 25x10



Coperchio bombato
Billied lid
cod. 242 cm. 26x9
cod. 241 cm. 22,5x7
cod. 240 cm. 16x7



Ovale PB liscio
Smooth oval
cod. 500 cm. 20x13x4,5
cod. 501 cm. 25x17x5,5
cod. 502 cm. 32x22x5,5
cod. 503 cm. 35x25x7
cod. 499 cm. 40x27x8,5



Padella bassa
Low frying-pans
cod. 271 cm. 17x2,5
cod. 272 cm. 20x3
cod. 273 cm. 26x3,5



Insalatiera 2 manici "au"
Salad bowl "au" handles
cod. 201 cm. 30x11
cod. 202 cm. 25x9,5
cod. 204 cm. 16x7
cod. 203 cm. 10x5



Bicchiere bombato senza manici
Billied beaker without handle
cod. 701 Lt. 0,25



Boccale bombato
Billied Jug
cod. 734 Lt. 1,5
cod. 733 Lt. 1
cod. 732 Lt. 0,5
cod. 731 Lt. 0,25
cod. 730 Lt. 0,20



Piatto piano
Plate
cod. 803 cm. 26x2



Piatto piano
Plate
cod. 802 cm. 23



Piatto fondo
Soup plate
cod. 801 cm. 19x6



Piatto frutta
Fruit Plate
cod. 800 cm. 20x2,5



Piatto piano
Plate
cod. 805 cm. 25



DE SILVA CERAMICHE SRL

Sede legale: Via Gramsci, 19 - Passignano sul Trasimeno - Perugia
Stabilimento: Zona Industriale Nord - 06023 Gualdo Tadino (PG)
Tel. 0759141431 - Fax 0759141431
E-mail: desilva@desilvaceramiche.it - Http://www.desilvaceramiche.it

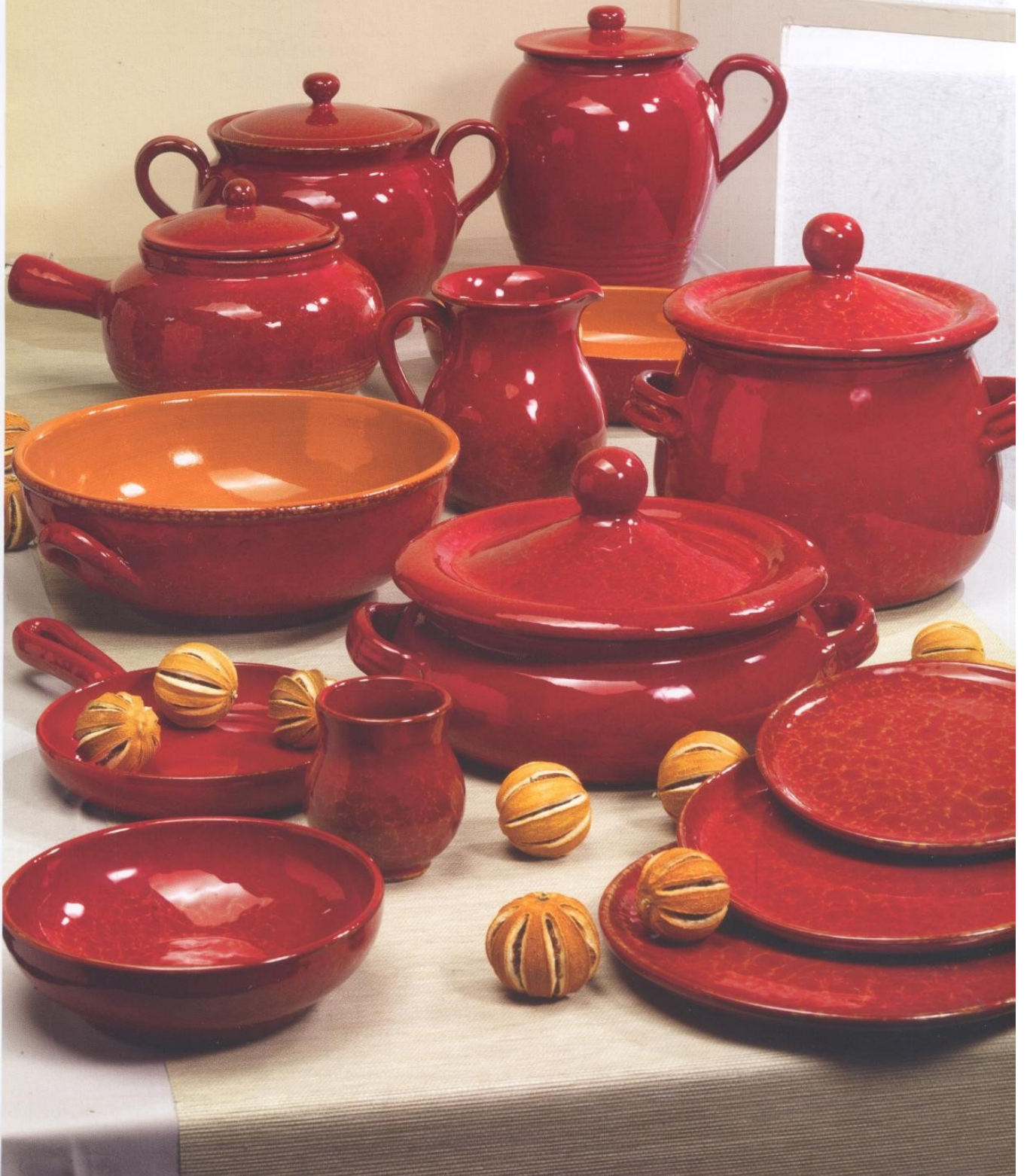



Collezione "ROSY 2" (Listino terza fascia)
"ROSY 2" Collection

	<p>Umidiiera bombata c/coperchio Stew dish billied with lid cod. 080 + 090 cm. 20x10,5 cod. 081 + 091 cm. 23x12,5</p>		<p>Piatto frutta Gaia Fruit plate cod. 610 cm. 19</p>		<p>Botte 1° misura Cask cod. 915 cm. 9x13</p>
	<p>Casseruola bombata 2 manici con coperchio Series billied casserole with two handles and lid cod. 073 + 090 cm. 20x6</p>		<p>Piatto fondo Gaia Soup plate cod. 611 cm. 21</p>		<p>Botte 2° misura Cask cod. 916 cm. 11x15 Botte 4° misura Cask cod. 917 cm. 16x19</p>
	<p>Casseruola fondue 1 manico Casserole 1 handle cod. 119 cm. 22x8,5</p>		<p>Piatto piano Gaia Plate cod. 612 cm. 23</p>		<p>Boccale Jug billied cod. 734 lt. 1,5 cod. 733 lt. 1 cod. 732 lt. 0,5 cod. 731 lt. 0,25 cod. 730 lt. 0,20</p>
	<p>Casseruola 2 manici fascia Casserole with 2 handles cod. 180 cm. 20x7,5 cod. 181 cm. 22x8 cod. 182 cm. 23x9</p>		<p>Piatto piano Gaia Plate cod. 614 cm. 26</p>		<p>Bicchiere Balena Beaker cod. 680 lt. 0,25</p>
	<p>ciotolone 2 manici Salad bowl with 2 handles cod. 203 cm. 10x5 cod. 204 cm. 16x7 cod. 202 cm. 25x9,5 cod. 201 cm. 30x11</p>		<p>Piatto piano Gaia Plate cod. 613 cm. 27</p>		



DE SILVA CERAMICHE SRL

Sede legale: Via Gramsci, 19 - Passignano sul Trasimeno - Perugia

Stabilimento: Zona Industriale Nord - 06023 Gualdo Tadino (PG)

Tel. 0759141431 - Fax 0759141431

e-mail: desilva@desilvaceramiche.it - <http://www.desilvaceramiche.it/>



Collezione "RUSTICO" marrone (Listino seconda fascia)
Brown "RUSTIC" Collection (Price list 2° type)

	Boccale cilindrico CM <i>Cylindrical jug</i> cod. 720 CM		Copriformaggio con piatto <i>Cheese plate with lid</i> cod. 350 piccolo / small cod. 351 grande / big		Rostiera con coperchio <i>Roast dish with lid</i> cod. 575 cm. 42,5 x 27 x 8 cod. 576 cm. 32,5 x 21 x 6,5		
	Bicchieri cilindrico alto <i>High cylindrical beaker</i> cod. 710		Cilindrico basso <i>Low cylindrical</i> cod. 705		Barriera piccola <i>Small butter holder</i> cod. 352		Rostiera senza coperchio <i>Roast dish without lid</i> cod. 577 cm. 23 x 14,5 x 5
	Ciotolina svasata <i>Small bowl</i> cod. 331		Caffè per 2 / vassoio quadrato <i>2 cups of coffee with square tray</i> cod. CAQ		Porta mestolo <i>Ladle holder</i> cod. 355		
	Pentolina bombata 2 manici c.t. <i>Series billeted pot with two handles and lid</i> cod. 120 cm. 8 x 7,5 cod. 121 cm. 10 x 9 cod. 122 cm. 11 x 11 cod. 123 cm. 11 x 11		Giambellone liscio <i>Smooth cake</i> cod. 610 cm. 6 x 4,5 cod. 611 cm. 10 x 6,5		Piatto frutta "Gaia" <i>Fruit "Gaia"</i> cod. 810 cm. Ø 19 Fondo "Gaia" <i>Soup plate "Gaia"</i> cod. 811 cm. Ø 21 Piano / Plate cod. 812 cm. Ø 23 cod. 813 cm. Ø 27		
	Cuocipatate <i>Bake - potatoes</i> cod. 200		Pentolina cilindrica 2 manici c.t. <i>Cylindrical pot with two handles and lid</i> cod. 130 cm. 8 x 7,5 cod. 131 cm. 10 x 9		Umidiere c/t <i>Stew dish with lid</i> cod. 030 - 040 cm. 15 x 9,5 cod. 031 - 041 cm. 18 x 11,5 cod. 032 - 042 cm. 21 x 13 cod. 033 - 043 cm. 24 x 15		
	Casseruola bombata 2 manici <i>Series billeted casserole with two handles</i> cod. 126 cm. 9 x 4		Casseruola cilindrica 2 manici con c.t. <i>Cylindrical casserole with two handles and lid</i> cod. 140 cm. 8 x 5 cod. 141 cm. 10 x 5,5		Insalatiera <i>Salad bowl</i> "Gaia" cod. 097 cm. 24 x 8,5		
	Casseruola 2 manici <i>Casserole with two handles</i> cod. 001 cm. 12x5 cod. 002 cm. 15x6 cod. 003 cm. 18x7 cod. 004 cm. 21x8 cod. 005 cm. 24x8,5 cod. 006 cm. 27x10 cod. 007 cm. 30x11		Antipastiera per 3 <i>Hors d'oeuve tray for tree</i> cod. 665				



DE SILVA CERAMICHE SRL

Sede legale: Via Gramsci, 19 - Passignano sul Trasimeno - Perugia
 Stabilimento: Zona Industriale Nord - 06023 Gualdo Tadino (PG)
 Tel. 0759141431 - Fax 0759141431
 E-mail: desilva@desilvaceramiche.it - [Http://www.desilvaceramiche.it/](http://www.desilvaceramiche.it/)

Collezione "RUSTICO" marrone (Listino seconda fascia)
Brown "RUSTIC" Collection (Price list 2° type)

Colore Marrone (Listino prima fascia)
Brown Colour (Price list 1° type)

Collezione "TABACCO" (Listino seconda fascia)
"TABACCO" Collection (Price list 2° type)

Colore Verdone (Listino prima fascia)
Green Colour (Price list 1° type)

Collezione "UVA" (Listino terza fascia)
"UVA" Collection (PRICE list 3° type)

Collezione "SCREZIATO" (Listino seconda fascia)
"SCREZIATO" Collection (Price list 2° type)

Collezione "EDERA" (Listino terza fascia)
"EDERA" Collection (Price list 3° type)



Padella
Frying-pan

Cm. Cod. nuovo
New code

17x2,5	271
20x3	272
26,5x3,5	273



DE SILVA CERAMICHE SRL

Sede legale: Via Gramsci, 19 - Passignano sul Trasimeno - Perugia



















Stabilimento: Zona Industriale Nord - 06023 Gualdo Tadino (PG)

Tel. 0759141431 - Fax 0759141431

E-mail: desilva@desilvaceramiche.it - [Http://www.desilvaceramiche.it/](http://www.desilvaceramiche.it/)



Collezione "SCREZIATO" (Listino seconda fascia)
"SCREZIATO" Collection (Price list 2° type)

	Umidiera bombata Stew dish billied cod. 080 cm. 20x10,5 cod. 081 cm. 23x12,5		Pentola 2 manici c/c Billied pot with two handles and lid cod. 083 + 090 cm. 18x16 cod. 084 + 091 cm. 21x18		Zuppino 2 manici Soup bowl with two handles cod. 290 cm. 13x6,5
	Tino Tun cod. 761 piccolo / small cod. 760 grande / big		Pentolina bombata 2 manici c/c Series billied pot with two handles and lid cod. 120 cm. 8 x 7,5 cod. 121 cm. 10 x 9		Stampo limone Print lemon cod. 360
	Boccale svasato Jugs series flared cod. 740 cm. h. 17		Casseruola bombata 1 manico Casserole billied with 1 handle cod. 060 cm. 12x4,7 cod. 061 cm. 14x5 cod. 062 cm. 17x7 cod. 063 cm. 20x8 cod. 064 cm. 23x9 cod. 065 cm. 26x9,5		Rettangolo Rectangle cod. 536 cm. 30 x 20 x 6 cod. 537 cm. 38 x 24 x 6,5
	Bicchiere svasato Beaker series flared cod. 719 cm. h.8 cod. 720 cm. h.10		Colazione per 2 / vassoio ovale Breakfast for 2 with oval tray cod. COB		Insalatiera "A" Salad bowl "A" cod. 835 cm. 24 x 10
	Lattiera bombata grande Big billied milk cod. 750		Teglia 2 manici Baking-pan with two handles cod. 255 cm. 30 x 8		Piatto frutta ciotola Fruit bowl cod. 800 cm. Ø 19
	Ovale liscio Smooth oval cod. 500 cm. 20x13,5x4,5 cod. 501 cm. 25x17x5,5 cod. 502 cm. 32x22x5,5 cod. 503 cm. 35x25x7 cod. 499 cm. 40x27x8,5		Teglia 1 manico Baking pans with one handle cod. 256 cm. 15 x 4,5 cod. 257 cm. 18 x 5		Piatto piano ciotola Plate bowl cod. 802 cm. Ø 23
					Pesce Fish Cod. 660





















DE SILVA CERAMICHE SRL

Sede legale: Via Gramsci, 19 - Passignano sul Trasimeno - Perugia
 Stabilimento: Zona Industriale Nord - 06023 Gualdo Tadino (PG)
 Tel. 0759141431 - Fax 0759141431

E-mail: desilva@desilvaceramiche.it - Http://www.desilvaceramiche.it/



Collezione "SIENA" (Listino seconda fascia)
 "SIENA" Collection (Price list 2° type)

	Pentola alta <i>Deep pot</i> cod. 025 cm. 15 x 13 cod. 026 cm. 16 x 16 cod. 027 cm. 21 x 16		Boccale bombato "S". Jug billed "S" cod. 734 lt. 1 1/5 cod. 733 lt. 1 cod. 732 lt. 0,5 cod. 731 lt. 0,250 cod. 730 lt. 0,200		Vassoio <i>Trays</i> cod. 962 cm 35 x 19,5 cod. 960 cm 27,5 x 14 cod. 961 cm 36,5 x 25
	Coperchio <i>Lid</i> cod. 040 cm. Ø 15 cod. 041 cm. Ø 16 cod. 042 cm. Ø 21		Boccale cilindrico CM <i>Jug cylindrical</i> cod. 720		Lattiera bombata <i>Milk - jugs series billed</i> cod. 753
	Casseruola 1 manico rotondo <i>Casserole with one round handle</i> cod. 049 cm. Ø 12 cod. 050 cm. Ø 15 cod. 051 cm. Ø 16 cod. 052 cm. Ø 21 cod. 053 cm. Ø 24		Bicchiere cilindrico alto <i>Beaker high cylindrical</i> cod. 710		Zuccheriera bombata C.C <i>Sugarbasin series billed</i> cod. 965 cm. 9,5x5
	Tondo rigato <i>Shaped low round</i> cod. 616 cm. 25 x 5 cod. 617 cm. 30 x 5		Bicchiere cilindrico con manico <i>Beaker low cylindrical with handle</i> cod. 705		Tazza thé <i>Tea cup</i> cod. 664 cm. 10x9
	Ovale P.B. liscio <i>Smooth series oval</i> cod. 500 cm. 20x13,5x4,5 cod. 501 cm. 25x17x5,5 cod. 502 cm. 32x22x5,5 cod. 503 cm. 35x25x7 cod. 499 cm. 40x27x5,5		Bicchiere cilindrico senza manico <i>Beaker low cylindrical without handle</i> cod. 706		Lattiera bassa <i>Low milk - jug</i> cod. FLB
	Insalatiera <i>Salad bowl</i> cod. 655 cm. Ø 16 x 7 cod. 656 cm. Ø 25 x 9,5 cod. 657 cm. Ø 30 x 11 cod. 325 cm. Ø 10 x 5		Piatto pizza inciso <i>Plate pizza with incision</i> cod. 620 cm. Ø 31		Piatto frutta "GAIA" <i>Fruit plate "GAIA"</i> cod. 610 cm. Ø 19
					Fondo ciotola c.bordo <i>Soup plate with border</i> cod. 604 cm. Ø 19
					Piatto piano "GAIA" - Plate "GAIA" cod. 614 cm. Ø 26



DE SILVA CERAMICHE SRL

Sede legale: Via Gramsci, 19 - Passignano sul Trasimeno - Perugia
 Stabilimento: Zona Industriale Nord - 06023 Gualdo Tadino (PG)
 Tel. 0759141431 - Fax 0759141431
 E-mail: desilva@desilvaceramiche.it - [Http://www.desilvaceramiche.it/](http://www.desilvaceramiche.it/)



Collezione "SOLE" (giallo) - Collezione "VENERE" (verde) - Collezione "NETTUNO" (celeste)
 "SOLE" collection (yellow) - "VENERE" collection (green) - "NETTUNO" collection (light blue)
 (1° fascia + 20% - Price list 1° type + 20%)

	<p>Pentola bombata con coperchio <i>Billed pot with lid</i> cod. 219 + 240 cm. Ø 11,5 x 15 cod. 220 + 241 cm. Ø 18 x 22</p>		<p>Boccale bombato / Jug billed cod. 734 lt. 1 1/2 cod. 733 lt. 1 cod. 732 lt. 1/2 cod. 731 lt. 1/4 cod. 730 lt. 1/5</p>		<p>Piatto frutta Gaia <i>Fruit plate</i> cod. 810 cm. 19</p>
	<p>Casseruola bombata 2 manici <i>Billed casserole 2 handles</i> cod. 225 cm. 15 x 7 cod. 226 cm. 22 x 9 cod. 227 cm. 25 x 10</p>		<p>Bicchiere bombato con manico <i>Beaker with handle</i> cod. 700 lt. 0,25</p>		<p>Piatto piano Gaia <i>Plate</i> cod. 814 cm. 26</p>
	<p>Casseruola bombata 1 manico <i>Billed casserole 1 handle</i> cod. 230 cm. 15 x 7 cod. 231 cm. 22 x 9 cod. 232 cm. 25 x 10</p>		<p>Serie ovale liscio <i>Smooth oval</i> cod. 500 cm. 20 x 3,5 x 4,5 cod. 501 cm. 25 x 17 x 5,5 cod. 502 cm. 32 x 22 x 5,5 cod. 503 cm. 35 x 25 x 7 cod. 499 cm. 40 x 27 x 8,5</p>		<p>Fornello bagna cauda <i>Stove</i> cod. 285 cm. 15x10,5</p>
	<p>Coperchio bombato / Billed lid cod. 240 cm. 16 x 7 cod. 241 cm. 22,5 x 7 cod. 242 cm. 26 x 9</p>		<p>Casseruola rotonda 2 manici <i>Round gratin 2 handles</i> cod. CBJ cm. 17 x 5,5</p>		<p>Casseruola fondue <i>Casserole fondue</i> cod. 118 cm. Ø 12 x 7,5 cod. 119 cm. Ø 21,5 x 8,5</p>
	<p>Tazza colazione bombata 02 c/piatto <i>Billed breakfast cup 02 w/dish</i> cod. 866 cm. 10 x 9,5 - cup cod. 865 cm. 18 - dish</p>		<p>Piatto fondo ciotola c/bordo <i>Soup plate with border</i> cod. 804 cm. Ø 19</p>		
	<p>Tazza caffè bombata 02 <i>Billed coffee cup 02</i> cod. 873 cm. 6,5 x 5</p>				



DE SILVA CERAMICHE SRL

Sede legale: Via Gramsci, 19 - Passignano sul Trasimeno - Perugia







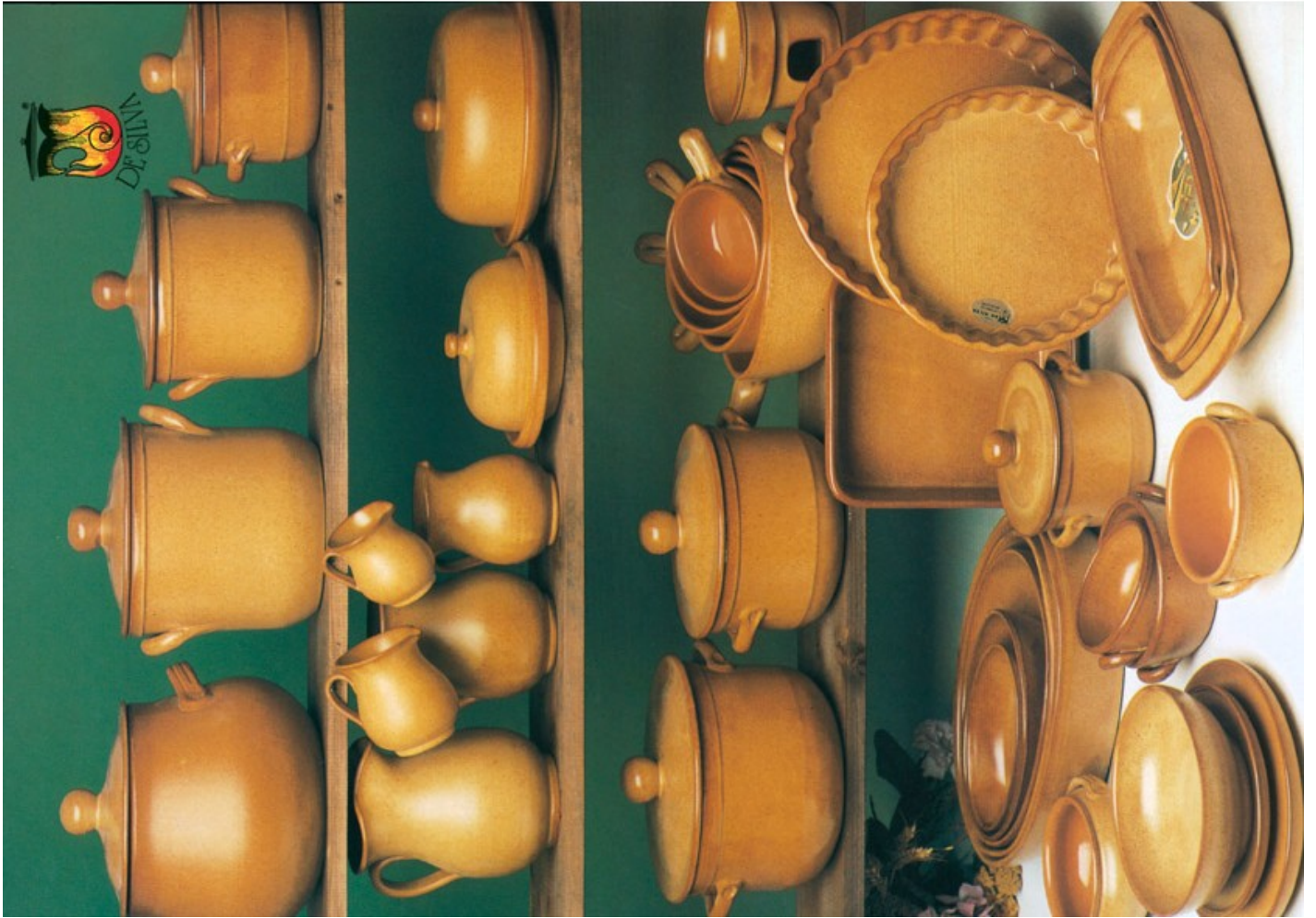







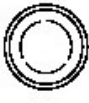

Stabilimento: Zona Industriale Nord - 06023 Gualdo Tadino (PG)

Tel. 0759141431 - Fax 0759141431

e-mail: desilva@desilvaceramiche.it - <http://www.desilvaceramiche.it/>

























**Collezione "TABACCO" (Listino seconda fascia)
"TABACCO" Collection (Price list 2° type)**

	Pentola 2 manici c.c. Enlised pot with two handles and lid cod. 082 - 040 cm. 15 cod. 083 - 041 cm. 18 cod. 084 - 042 cm. 21		Piatto piano Plate cod. 802 cm. 23 cod. 803 cm. 27 cod. 806 cm. 32
	Pentola c.c. Pot with lid cod. 025 - 040 cm. 15 cod. 026 - 041 cm. 18 cod. 027 - 042 cm. 21		Piatto fondo Soup plate cod. 801 cm. 19
	Unidiera Stew dish cod. 030 - 040 cm. 15 cod. 031 - 041 cm. 18 cod. 032 - 042 cm. 21 cod. 033 - 043 cm. 24		Piatto frutta Fruit plate cod. 800 cm. 19
	Casseruola 2 manici Casserole with two handles cod. 001 cm. 12 cod. 002 cm. 15 cod. 003 cm. 18 cod. 004 cm. 21 cod. 005 cm. 24 cod. 006 cm. 27 cod. 007 cm. 30		Piatto pizza Plate pizza cod. 815 cm. 30
	Casseruola 1 manico Casserole with one handle cod. 008 cm. 12 cod. 009 cm. 15 cod. 010 cm. 18 cod. 011 cm. 21 cod. 012 cm. 24		Bagna cauda Stove cod. 285
	Zuppino 2 manici Soup bowl with two handles cod. 290 cm. 13		Quadrata liscia Smooth square cod. 545 cm. 24x24x5,5 cod. 546 cm. 32x32x8
	Casseruola Enlised casserole cod. 055 cm. 12 2M 02		Ton do rigato Striped round cod. 616 cm. 25x4,5 cod. 617 cm. 30x4,5
	Boccale Bombato Enlised /ugs cod. 734 Lt. 1/2 cod. 733 Lt. 1 cod. 732 Lt. 1/2 cod. 731 Lt. 1/4 cod. 730 Lt. 1/5		Ovale liscio Smooth oval cod. 500 cm. 20x3 5x4,5 cod. 501 cm. 25x17x3,5 cod. 502 cm. 32x22x3,5 cod. 503 cm. 35x25x7 cod. 499 cm. 40x27x8,5
	Caprifo maggio con piatto Cheese plate with lid cod. 351 grande / big cod. 350 piccolo / small		Rettaangolare Rectangle cod. 534 cm. 30x16 5x4,5 cod. 533 cm. 34x18x5,5 cod. 532 cm. 38x20x6



DE SILVA CERAMICHE SRL
Sede legale: Via Gramsci, 19 - Passignano sul Trasimeno - Perugia
Stabilimento: Zona Industriale Nord - 06023 Guardo Tadino (PG)
Tel. 0759141431 - Fax 0759141431
E-mail: desilva@desilvaceramiche.it - Http://www.desilvaceramiche.it/

Collezione "TAVERNA SU SCREZIATO" (Listino terza fascia)
 "TAVERNA SU SCREZIATO" Collection (Price list 3° type)

	Lattiera cilindrica Cylindrical milk - jug cod. 760 cm. 8 cod. 761 cm. 9		Casseruola 2 manici c.& DS Casserole with two handles and lid cod. 282 - 041 cm. 18 cod. 283 - 042 cm. 21 cod. 284 - 043 cm. 24
	Tazza Jumbo Jumbo cup cod. 863		Bottiglia Bottle cod. BVM piccolo / small cod. BGM grande / big
	Porta spaghetti Spaghetti holder cod. PSP - cm. Ø 11xh. 29		Umidiere c.&f. Steamer with lid cod. 031 - 042 cm. 21
	Tazza colazione Breakfast cup cod. 861		Pentola 2 manici c.&f. Pot with two handles and lid cod. 027 - 042 cm. 21
	Zuccheriera Sugarbasin cod. 960		Copriformaggio con piatto Cheese plate with lid cod. 351
	Caffè per 2 / vaso quadrato 2 cups of coffee with square tray cod. CAQ		Cattino Basin cod. 328 cm. Ø 10 cod. 330 cm. Ø 25
	Casseruola 1 manico Casserole with one handle cod. 009 cm. 15 cod. 010 cm. 18		Botte c.&f. Cask with lid cod. 915 cm. Ø 9 x h. 12 cod. 916 cm. Ø 11 x h. 15 cod. 917 cm. Ø 16 x h. 19
	Casseruola 1 manico c.&f. Casserole with one handle and lid cod. 011 - 042		Rettangolo Rectangle cod. 536 cm. 30 x 20 x 6 cod. 537 cm. 38 x 24 x 6,5
	Casseruola 2 manici c.&f. Casserole with two handles and lid cod. 004 - 042 cm. 21		Zuppino 2 manici Soup bowl with two handles cod. 290 cm. 13
	Pentola 2 manici c.&f. Pot with two handles and lid cod. 083 - 042 cm. 18 cod. 084 - 043 cm. 21		Ovale rigato Striped oval cod. 508 cm. 40 x 27 x 8 cod. 509 cm. 37 x 24 x 7 cod. 510 cm. 32 x 21 x 6,5
	Casseruola 2 manici c.&f. bombata Bulged casserole with two handles and lid cod. 072 - 080 cm. 17 cod. 073 - 080 cm. 20 cod. 074 - 091 cm. 23		Ovale pesce / Oval fish cod. 648 cm. 20 x 35 cod. 650 cm. 27,5 x 17 cod. 651 cm. 33 x 19 cod. 652 cm. 37 x 23



DE SILVA CERAMICHE SRL

Sede legale: Via Gramsci, 19 - Passignano sul Trasimeno - Perugia







Stabilimento: Zona Industriale Nord - 06023 Gualdo Tadino (PG)





Tel. 0759141431 - Fax 0759141431

E-mail: desilva@desilvaceramiche.it - [Http://www.desilvaceramiche.it/](http://www.desilvaceramiche.it/)



Collezione "VECCHIA CUCINA" (Listino terza fascia)
 "OLD KITCHEN" Collection (Price list 3° type)

	Retriangolo - Rectangle Cod. 536 cm. 30x20x6 Cod. 537 cm. 38x24x6,5
	Retriangolo rigato alto Deep striped rectangle Cod. 530 cm. 32x23x6
	Budino - Pudding Cod. 620 cm. 25x10,5
	Coperchio bombato Series billeted lid Cod. 089 cm. 17 Cod. 090 cm. 20 Cod. 091 cm. 24 Cod. 092 cm. 26
	Casseruola bombata 1 manico Series billeted casserole w/1 handle Cod. 060 cm. 12x4,7 Cod. 061 cm. 14x5 Cod. 062 cm. 17x7 Cod. 063 cm. 20x8 Cod. 064 cm. 23x9 Cod. 065 cm. 26x9,5
	Pentola bombata - Series billeted pot Cod. 082 cm. 16x15,5 Cod. 083 cm. 18x16 Cod. 084 cm. 21x18

	Servizio pinzimonio 7 pezzi Cod. PZZ
	Botte con coperchio - Cask with lid Cod. 915 cm. 9x13 Cod. 916 cm. 11x15 Cod. 917 cm. 16x19
	Boccale bombato "S" - Jug billeted "S" Cod. 794 fl. 1/5 Cod. 793 fl. 0,5 Cod. 792 fl. 0,5 Cod. 791 fl. 0,250 Cod. 790 fl. 0,200
	Bicchere bombato con manico Beakers billeted with handle Cod. 700
	Servizio colazione 4 pezzi Cod. OCL



DE SILVA CERAMICHE SRL
 Sede legale: Via Gramsci, 19 - Passignano sul Trasimeno - Perugia
 Stabilimento: Zona Industriale Nord - 06023 Gualdo Tadino (PG)
 Tel. 0759141431 - Fax 0759141431
 E-mail: desilva@desilvaceramiche.it - [Http://www.desilvaceramiche.it/](http://www.desilvaceramiche.it/)

**COTTO RUSTICO
VERDONE
DEEP GREEN**



Umiedera bombata c/coperchio
Bilixed stew pot with lid
Cod. 068 - Ø 62 cm. 20
Cod. 069 - Ø 63 cm. 24



Casseruola bombata 1manico
Series bilixed casseroles with one handle
Cod. 040 Ø cm. 12
Cod. 045 Ø cm. 14
Cod. 046 Ø cm. 17
Cod. 047 Ø cm. 20
Cod. 048 Ø cm. 23
Cod. 030 Ø cm. 26



Broccione
Big jug
Cod. 417



Cuoci legumi
Boil legume
Cod. 415



Pentola bombata c/coperchio
Series bilixed pot with lid
Cod. 032 - Ø 23 cm. 16
Cod. 033 - Ø 24 cm. 18
Cod. 034 - Ø 25 cm. 21



Rettangolo
Rectangle
Cod. 597 cm. 30x20x6



Rettangolo
Rectangle
Cod. 177 cm. 38x24x6,5



Remequin
Small ramekin
Cod. 569/A Ø cm. 8



Ovale
Series oval
Cod. 072 cm. 20x13,5x4,5
Cod. 073 cm. 25x17x5,5
Cod. 182 cm. 32x22x5,5
Cod. 074 cm. 35x25x7
Cod. 178 cm. 40x27x8,5



Ovale c/manici
Series oval with handles
Cod. 142/A cm. 20,5x12,5x3
Cod. 142 cm. 26x15x4
Cod. 141 cm. 40x25x6,5



Casseruola bombata 2 manici
Series bilixed casseroles with two handles
Cod. 041 Ø cm. 12
Cod. 049 Ø cm. 14
Cod. 050 Ø cm. 17
Cod. 051 Ø cm. 20
Cod. 052 Ø cm. 23
Cod. 053 Ø cm. 26

DE SILVA CERAMICHE ARTISTICHE SRL

SEDE LEGALE: VIA GRAMSCI, 19 - PASSIGNANO SUL TRASIMENO - PERUGIA
STABILIMENTO: ZONA INDUSTRIALE NORD - 06023 GUALDO TADINO (PG)
TEL. (075) 9141431 - FAX 9141431



Collezione "SAFARI GIALLO" "Yellow Safari" Collection



Pentola bombata con coperchio Etrusca
Billied pot with lid Etrusca
cod. 219+240 cm. 11,5x15
cod. 220+241 cm. 18x22



Umidiera bombata 2 manici Etrusca
Billied stew dish with 2 handles Etrusca
cod. 235 cm. 21x12,5



Casseruola con bordo 2 manici fascia
Casserole with 2 handles
cod. 180 cm. 20x8
cod. 181 cm. 22x8,5
cod. 182 cm. 23x9
cod. 183 cm. 24x9



Casseruola bombata 2 manici Etrusca
Billied casserole 2 handles etrusca
cod. 225 cm. 15x7
cod. 226 cm. 22x9
cod. 227 cm. 25x10



Casseruola bombata 1 manico etrusca
Series billied casserole with 1 handles Etrusca
cod. 230 cm. 15x7
cod. 231 cm. 22x9
cod. 232 cm. 25x10



Coperchio bombato billied
Lid
cod. 240 cm. 16x7
cod. 241 cm. 22,5x7
cod. 242 cm. 26x9



Rettangolo
Rectangle
cod. 630 cm. 23x18x6
cod. 631 cm. 30x20x6
cod. 632 cm. 31x26,5x7



Ovale con manici
Oval with handles
cod. 480 cm. 21,5x14x4
cod. 481 cm. 32x22,5x5
cod. 482 cm. 36x26x6



Casseruola fondue 1 manico aperto
Fondue casserole 1 handle
cod. 110 cm. 12x7,5

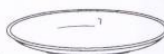

Vassoio ovale
Series oval tray
cod. 649 cm. 20x3,5
cod. 650 cm. 27,5x17
cod. 651 cm. 33x19
cod. 652 cm. 37x23



Boccale bombato
Billied Jug "S"
cod. 734 Lt. 1,5
cod. 733 Lt. 1
cod. 732 Lt. 0,5
cod. 730 Lt. 0,20
cod. 731 Lt. 0,25



Tazza bombata Series
Billied Cup
cod. 860+865 cm. 12x8



Tazza bombata 02 con piatto
Billied breakfast 02 with dish
cod. 860+865 cm. 10x9,5



Piatto frutta Gaia
Fruit plate "Gaia"
cod. 810 cm. 19



Piatto fondo Gaia
Soup plate "Gaia"
cod. 811 cm. 21



Piatto piano Gaia
Plate "Gaia"
cod. 812 cm. 23



Piatto piano Gaia
Plate "Gaia"
cod. 814 cm. 26



Piatto piano Gaia
Plate
cod. 813 cm. 27



DE SILVA CERAMICHE SRL

Sede legale: Via Gramsci, 19 - Passignano sul Trasimeno - Perugia
Stabilimento: Zona Industriale Nord - 06023 Gualdo Tadino (PG)
Tel. 0759141431 - Fax 0759141431
E-mail: desilva@desilvaceramiche.it - Http://www.desilvaceramiche.it



Collezione MIELE (con bordo) Honey Collection (with rim)



Umidiera con coperchio Serie Romana

Stew dish with lid Roman Series

cod. R/5+R8 - cm 17x11

cod. R/6+R9 - cm 21x13

cod. R/7 + R10 cm 24,5x15



Tagina

Tajine

cod. 353 grande / large - cm 25x26

cod. 341 piccola / small - cm 20x13



Teglia serie Romana con coperchio

Baking pan Roman series with lid

cod. R/11+045 - cm 31x6,5



Bagna cauda

Stove

cod. 285 grande / large

cod. 286 piccola / small

cod. 287 Japan shape

cod. 288 FN



Casseruola 2 manici Serie Romana con coperchio

Casserole 2 handles Roman series with lid

cod. R1 - cm 14x5 (s/coperchio - without lid)

cod. R2+R8 cm 17x6,5

cod. R3+R9 cm 20x7,5

cod. R4+R10 cm 22x8,5



DE SILVA CERAMICHE SRL

Sede legale: Via Gramsci, 19 - Passignano sul Trasimeno - Perugia

Stabilimento: Zona Industriale Nord - 06023 Gualdo Tadino (PG)

Tel. 0759141431 - Fax 0759141431

e-mail: desilva@desilvaceramiche.it - <http://www.desilvaceramiche.it>



Collezione SAFARI Verde e Melanzana

Green SAFARI and Aubergine-eggplant Collection



Pentola bombata Serie Etrusca

Billied pot Etruscan series
 cod. 219 - cm 15x11,5
 cod. 217 - cm 16x13,5
 cod. 218 - cm 18x15
 cod. 220 - cm 22x18
 cod. 221 - cm 21x21



Casseruola bombata 2 manici

Series billied casserole 2 handles
 cod. 070 - cm 12x4,7
 cod. 071 - cm 14x5
 cod. 072 - cm 17x7
 cod. 073 - cm 20x8
 cod. 074 - cm 23x9
 cod. 075 - cm 26x9,5



Coperchio bombato Serie Etrusca

Billied lid Etruscan Series
 cod. 240 - cm 16x7
 cod. 241 - cm 22,5x7
 cod. 242 - cm 26x9
 cod. 243 - cm 18



Piatto fondo Serie Etrusca

Soup plate Etruscan Series
 cod. 826 - cm 20x6



Lasagnera rettangolare Etrusca

Rectangular Lasagna baker Etruscan Series
 cod. 543 - cm 35x23x8
 cod. 542 - cm 42x29x8



Piatto piano Serie Etrusca

Plate Etruscan Series
 cod. 823 - cm 27



Casseruola 2 manici

Casserole with 2 handles
 cod. 001 - cm 12x5
 cod. 002 - cm 15x6
 cod. 003 - cm 18x7
 cod. 004 - cm 21x8
 cod. 005 - cm 24x8,5
 cod. 006 - cm 27x10
 cod. 007 - cm 30x11
 cod. 022 - cm 33x11
 cod. 023 - cm 42x16



Insalatiera Etrusca

Etruscan Salad bowl
 cod. 850 - cm 24x6
 cod. M7/851 - cm 27x10
 cod. M3/852 - cm 30x10
 cod. M2/853 - cm 33x12
 cod. M/854 - cm 40x14



DE SILVA CERAMICHE SRL

Sede legale: Via Gramsci, 19 - Passignano sul Trasimeno - Perugia

Stabilimento: Zona Industriale Nord - 06023 Gualdo Tadino (PG)

Tel. 0759141431 - Fax 0759141431

e-mail: desilva@desilvaceramiche.it - <http://www.desilvaceramiche.it>



Collezione VERDE ACIDO sfumato *Distressed Olive Green Collection*



Casseruola 2 manici

Casserole with 2 handles

cod.001 - cm 12x5
cod.002 - cm 15x6
cod.003 - cm 18x7
cod.004 - cm 21x8
cod.005 - cm 24x8,5
cod.006 - cm 27x10
cod.007 - cm 30x11
cod.022 - cm 33x11
cod.023 - cm 42x16



Boccale bombato

Billed Jug "S"

cod. 734 Lt. 1,5
cod. 733 Lt. 1
cod. 732 Lt. 0,5
cod. 730 Lt. 0,20
cod. 731 Lt. 0,25



DE SILVA CERAMICHE SRL

Sede legale: Via Gramsci, 19 - Passignano sul Trasimeno - Perugia

Stabilimento: Zona Industriale Nord - 06023 Gualdo Tadino (PG)

Tel. 0759141431 - Fax 0759141431

e-mail: desilva@desilvaceramiche.it - <http://www.desilvaceramiche.it>